

**MANUAL FOR
TRAINED
PEN REPAIRMEN**

SHEAFFER'S

INTRODUCTION

This repair manual and the tools described herein should not be confused with the Servisette Kit.

The Servisette Kit has been designed for use by the average sales person who has not had repair experience. Many of the operations described in this manual should be attempted **only** by a skilled operator who has been properly instructed.

The tools shown in this manual may be purchased singly or in complete sets. The tools for pen repairs are known as the "Pen Repair Kit," and the tools for pencil repairs are known as the "Pencil Repair Kit."

The success of any pen department depends on **service** as well as sales. To help dealers develop more satisfied customers through correct pen repair service, we make available not only the Servisette Plan, but also a factory training course on the handling of more complicated repairs. Your Sheaffer representative will be glad to explain both the Servisette Plan and how you can enroll for the factory Sales and Service Training Course.

TABLE OF CONTENTS

	Page		Page
1. How to Fill a Lever Pen.....	3	23. How to Inspect Gold Point.....	14
2. How to Fill a Vacuum Pen.....	3	24. How to Remove Gold Point from Section	14
3. Further Rules for the Care of Any Fountain Pen	3-4	25. How to Straighten Gold Point....	15
4. If Pen Leaks or Floods.....	4	26. How to Space Gold Point.....	16
5. Diagram Showing Lever Pen and Parts	5	27. How to Replace Point in Section..	16
6. Diagram Showing Vacuum Pen and Parts	5	28. How to "Push" Point.....	16
7. Illustration of Bar, Lever and Sac Tools for Lever Pen.....	5	29. How to Mold Feed to Point.....	17
8. Illustration Showing Tools for Plunger Vacuum Pen.....	6	30. How to Fit "C" Type Feed to Point	17
9. Illustration Showing Point and Feed Tools	6	31. How to Smooth Point.....	17-18
10. Illustration Showing Polishing and Cleaning Tools	7	32. How to Fit Cap.....	18
11. How to Remove Section and Sac on Lever Pen.....	7-8	33. How to Increase Clip Tension....	18
12. How to Replace Section and Sac on Lever Pen.....	8	34. Illustration Showing Balance Pen- cil Parts	19
13. How to Assemble Lever.....	9	35. Illustration Showing Fineline "Turn Type" Pencil Parts.....	19
14. How to Adjust Bar and Lever....	9	36. Illustration Showing Pencil Re- pair Tools	19
15. How to Assemble Bar.....	10	37. How to Repair Propel-Repel-Expel (Turn Type) Pencils, Either in Regular Balance, Fineline Balance, or LE "In Working Togs" Models	20
16. How to Remove Plunger from Vacuum Type Pens.....	11	38. How to Correct "Lead Jam".....	20
17. How to Replace Plunger on Vac- uum Type Pens	11	39. How to Correct Damaged Tip....	20
18. Barrel Plug Adjustments.....	11	40. How to Adjust Loose Cap.....	20
19. How to Determine the Correct Plunger Size	12	41. How to Adjust "Locked" or "Loose" Mechanism	21
20. Plunger Assortment Chart for Wasp Clipper and Vacuum-Fil Pens	12	42. How to Tighten Eraser Fit.....	21
21. Plunger Assortment Chart for New-Style Tapered End Sheaffer Pens	13	43. Illustration Showing Three Sizes of Balance Type Pencil Mechan- isms	22
22. Plunger Assortment Chart for Old- Style Blunt End Sheaffer Pens...	13	44. How to Repair the Clicker (Push Type) Pencil	22-23
		45. Illustration Showing Fineline Clicker "Push Type" Pencil Parts.	23
		46. "At Your Service".....	24

RULES FOR THE CARE AND USE OF SHEAFFER PENS

Page
 int..... 14
 Point from 14
 Point.... 15
 it..... 16
 Section.. 16
 16
 Point..... 17
 Feed to 17
17-18
 18
 ension.... 18
 ance Pen- 19
 ineline s..... 19
 encil Re- 19
 pel-Expel Either in : Balance, s" Models 20
 am"..... 20
 l Tip.... 20
 up..... 20
 ked" or 21
 fit..... 21
 ree Sizes Mechan- 22
 er (Push22-23
 ineline cil Parts. 23
 24

Some customers may not know how to properly fill a pen or load a pencil. It is suggested this be first checked with them carefully when considering repair requests.

How To Fill a Lever Pen

1. Press all air from sac by raising lever.
2. Submerge entire gold point in writing fluid so air will not enter sac.
3. Close lever. Let point remain under fluid from seven to ten seconds (long count) to give sac time to draw in fluid. Improper filling causes many pens to be criticized for not holding enough fluid. If you hear air going into pen when you remove it from fluid, immerse pen and fill again.
4. Hold pen with point down so excess fluid will run off. Then wipe point with an absorbent cloth or blotter. Do not replace cap until all fluid has been wiped from point and section. See further information on page 4.

How To Fill a Vacuum Plunger Pen

1. Unscrew barrel cap and place entire gold point in writing fluid.
2. Pull out plunger as far as possible. See illustration A.
3. Push plunger in slowly, using care that entire gold point remains under surface of fluid. Note that pen is filled on down stroke of plunger and not on up stroke. See illustration B.

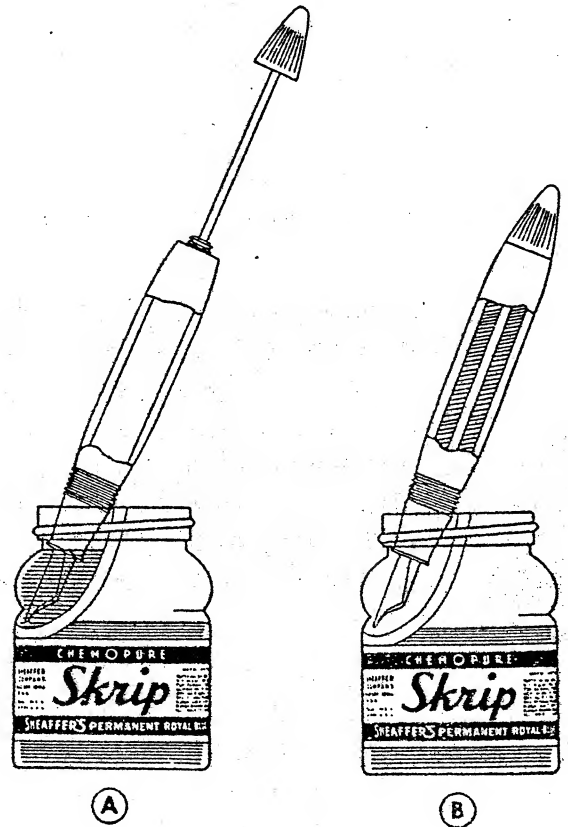

4. Wipe excess fluid from point as outlined in above instructions for filling lever-type pen.

Further Rules for the Care of Any Fountain Pen

1. Use SKRIP, "Successor to Ink." It will keep pen in good working order. Caution your customer never to mix writing fluids. If pen has some other fluid in it, flush thoroughly with water before re-filling with SKRIP.

2. When first filling a pen, fill and empty several times. This thoroughly washes feed channels and allows them to function properly.

3. Screw pen cap on tightly—give it an extra twist, holding the point up. This seals section against inner cap, keeping point moist, ready for instant use, and prevents fluid from seeping out. Customer should not lay pen down uncapped for any length of time as point may dry out and fail to write instantly when again used.

4. Pen should be flushed occasionally in clear, cold water. This prevents accumulation of any writing fluid residues.

5. Do not let pen lie flat for long intervals. This sometimes allows the comb cuts to fill full and may cause blotting when first used.

6. If Pen Leaks or Floods. Sometimes your customer will bring a pen to you commenting that "ink leaks into the cap" or "pen leaks."

A great many of these complaints on leaking can be eliminated by properly instructing the pen user. For short periods of time, a pen may be carried without trouble in any manner desired or allowed to lie flat during intermittent use. However, any pen may leak fluid into the cap if allowed to lie flat for a prolonged period or during a severe temperature change. Therefore, it is important that these conditions be borne in mind. We suggest that no pen be allowed to lie flat for a long period of time such as overnight or week ends. Avoid the possibility of fluid leaking into cap by seeing that the pen is left with the point in an elevated position during such periods.

After any pen has been properly

filled, there is a surplus of writing fluid in the feed. Therefore, please give these very important instructions to customer: Draw off surplus fluid with a blotter or absorbent cloth applied to the slit of the gold point. See illustration below:

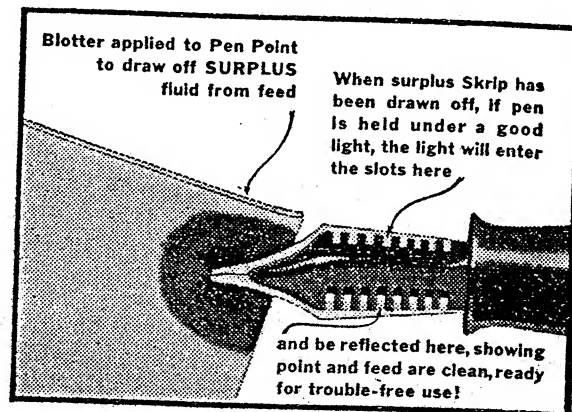

Note that the feed has "comb cuts." These slits are really capillary expansion chambers to take care of the extra fluid forced from pen by the expansion of air in the barrel reservoir. When pen is filled, excess fluid must be drawn from these chambers to make room for possible expansion. When pen has been lying flat for considerable length of time, these chambers may also fill. Excess fluid should be drawn from them with blotter or cloth before writing. If feed combs have surplus writing fluid thus absorbed, they will function properly and take care of normal expansion.

Another reason for leaking complaints is that writing fluid is not wiped from feed, section and threads before pen cap is screwed on. Then, when the cap is removed and writing fluid is found on the threads, section, and inside cap, it is assumed that the pen leaks.

If customers will follow the above instructions regarding the removal of surplus writing fluid, they will get consistently better service from their pens.

of writing fore, please nt instruc- w off sur- or absorbt- slit of the ion below:



as "comb eally capil- rs to take orced from air in the n pen is be drawn to make ion. When t for com- me, these ll. Excess from them efore writ- ve surplus rbed, they and take 1.

king com- fluid is not ction and is screwed cap is re- l is found and inside t the pen

the above e removal they will r service

PEN PARTS and REPAIR TOOLS

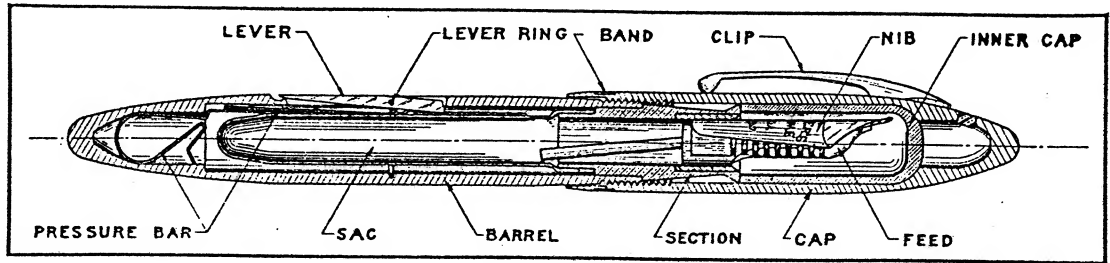

LEVER PEN

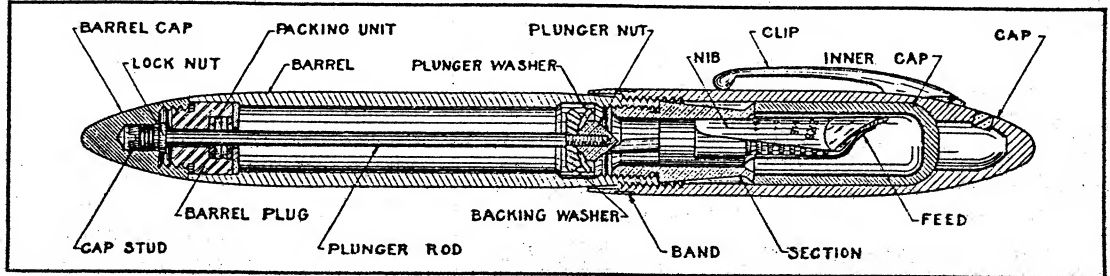

VACUUM PLUNGER PEN

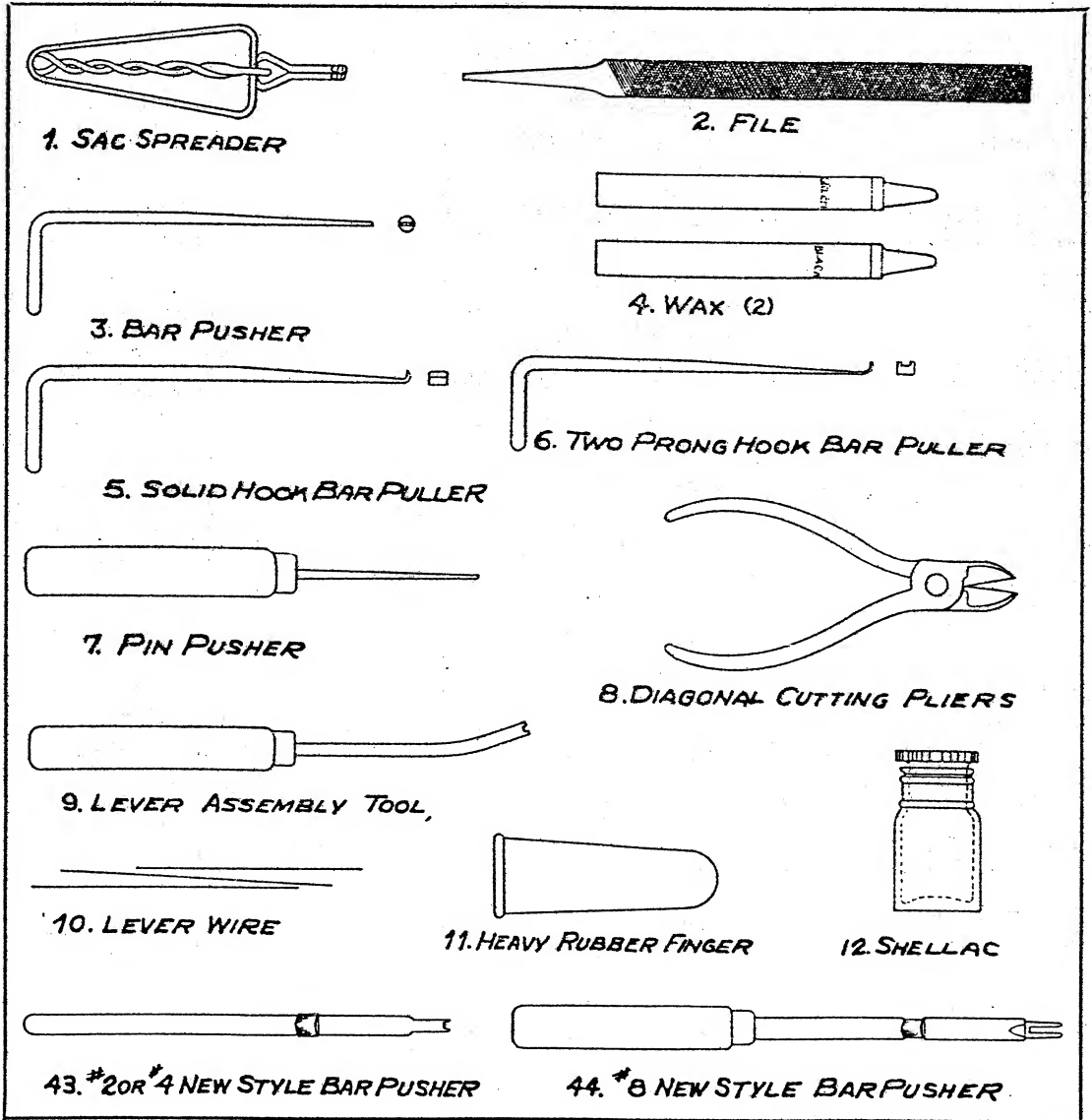

BAR, LEVER AND SAC TOOLS FOR LEVER PEN

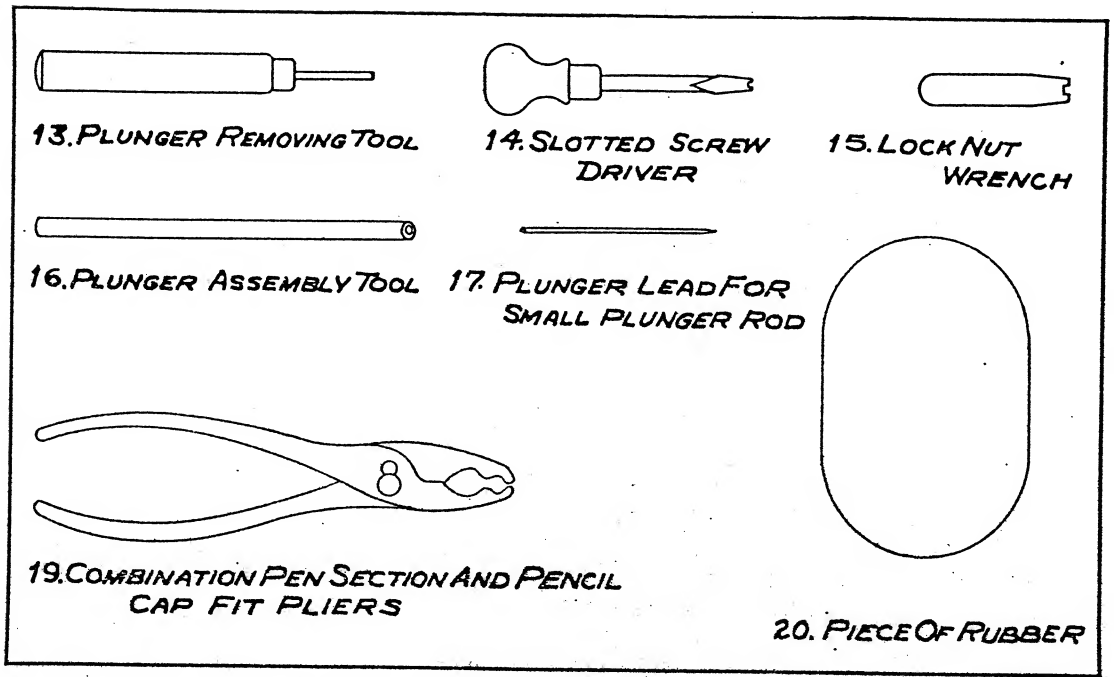

TOOLS FOR PLUNGER VACUUM PEN

POINT AND FEED TOOLS

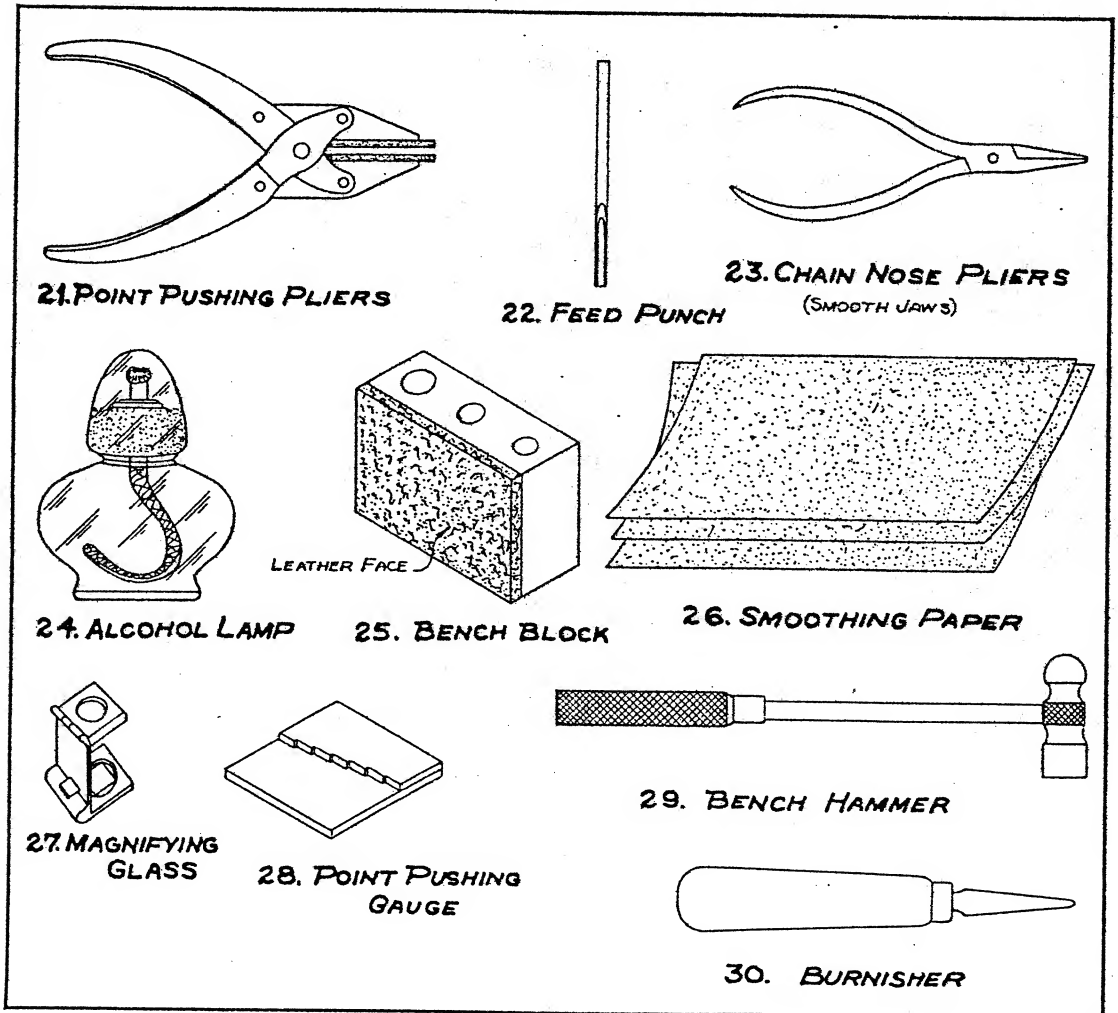

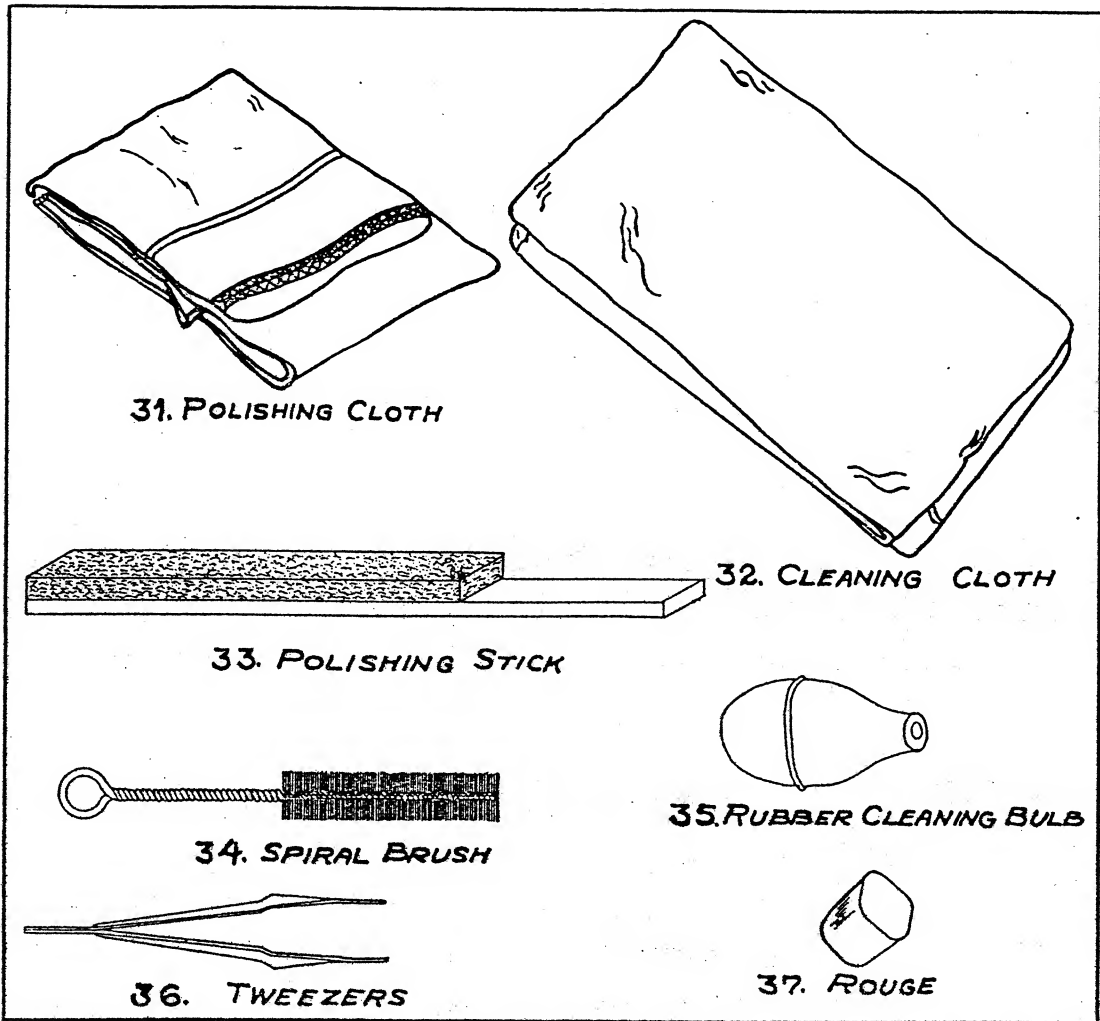
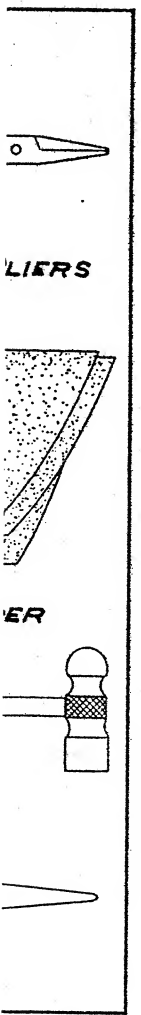
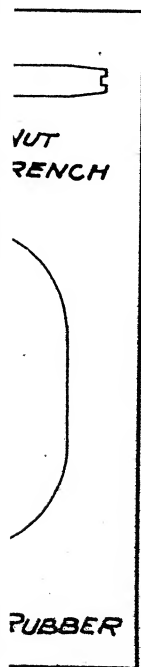

POLISHING-CLEANING TOOLS

HOW TO REMOVE AND REPLACE SAC ON LEVER PEN

A. To Remove Section and Sac:

1. Empty writing fluid from pen by raising lever. Discard this fluid. Then wipe off section, point and feed.
2. Twist or work section out of barrel. Use heavy rubber finger cot or piece of heavy rubber if necessary to provide a grip to protect the fingers.

"Visulated" transparent sections are cemented into barrel with

shellac and sometimes require extra pressure to break their seal. Accomplish this by pressing thumb first on one side and then the other of upper end of section. If enough pressure is applied, the seal can be broken and section "walked out." Sections in CREST pens (pens with all-gold caps) are threaded and, therefore, cannot be pulled out but must be unscrewed from barrel the same as sections in plunger vacuum pens. The threads on these sections are

coated with a special plastic cement to keep the section from turning. This cement should not be washed off. Use pliers and rubber as shown in illustration No. 9.

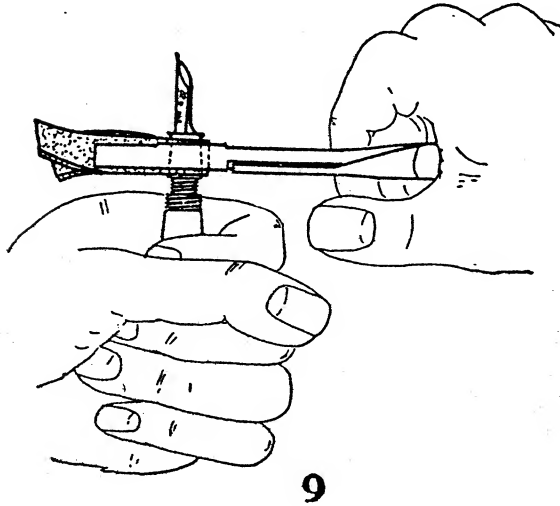

3. To remove sac from section, catch end of sac with your thumb nail, and with end of your thumb peel or roll sac off section.

4. If pen empties and fills freely it should indicate feed is not clogged and requires no further cleaning. However, if feed seems gummed up, slip the cleaning bulb (Tool No. 35) over end of section in place of sac and immerse point in cleaning solution.

Compress bulb and force solution in and out until the obstruction is removed. Rinse thoroughly by repeating the process, using clear water.

B. To Replace Section and Sac:

1. Select a new sac. Sac should fit loosely and turn freely in barrel and not press against bar, end or walls of barrel. Too much pressure might cause pen to flood. This new sac can be same size as old one, providing old sac was not too large. When uncertain about diameter and length of sac to use,

test by dropping sac into barrel. Sac should freely fall in and out. Also, allow for distance section fits into barrel, otherwise, sac will be too long.

2. To attach sac to section—spread cement around sac fit part of section. Use care that no cement gets on end of feed to stop it up. Then slip sac on section, using sac spreader. See illustration No. 24. Should sac slip off, too much cement has been used. Wipe off section and again put on sac. See that sac is placed straight on section.

Orange shellac is supplied in the Repair Kit as a cement for attaching sacs. Shellac is waterproof but glue which may be purchased in collapsible tubes may be used as a substitute.

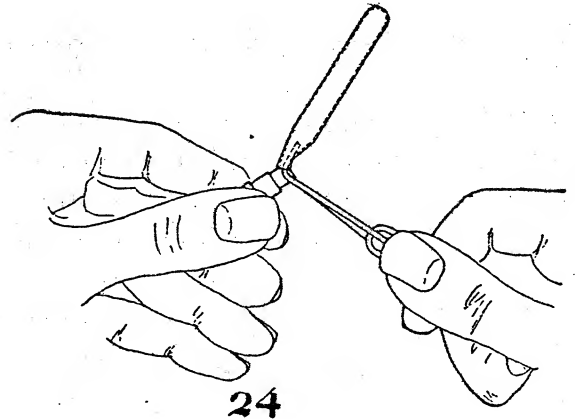

3. To push section into barrel—start section into barrel with point in line with lever (for uniform appearance) and push into place.

IMPORTANT: When replacing "Visulated" section, be sure to spread cement on the barrel fit part of section before pushing section in pen barrel. This insures a permanent fit of section and barrel. No surplus of shellac or cement should be allowed to touch outside of barrel for it will deaden luster. Wipe off any excess immediately.

HOW TO ADJUST LEVER PEN MECHANISMS

Lever Assembly

A. To assemble the lever which is held in place by a ring inside the barrel:

1. Place a wire lever ring through the hole in the lever. Then place the large end of lever in the end of lever assembly tool, (Tool No. 9). The ends of wire should point back toward the tool handle. See illustration No. 8.

2. With this tool, thread lever through the slot in barrel from the inside. When end of lever extends through the slot, grasp it with thumb and finger and remove the tool.

3. Spring lever ring into position in the groove inside the barrel by moving lever toward groove. A hook shaped tool, such as the bar puller (Tool No. 5), may be used to force the ring into the groove should it fail at first to snap into place.

B. To assemble the lever which is held in place by a wire run through the barrel walls:

This style lever is assembled in the barrel after the bar has been put in place.

1. Lay lever, finished side up, on the bar in the barrel slot.

2. Thread a piece of lever wire through the barrel drillings and the lever. The pressure of the bar against lever should hold lever firmly in place but lever should not push bar away from the inside barrel wall.

a. **TO TEST FOR PLAY:**
Hold barrel with lever down. Pull down lever

about $\frac{1}{8}$ of an inch (1.6 mm.), then release. If lever snaps back into place and the bar does not hang away from the inside wall of barrel, the lever adjustment is correct.

b. If lever has "play," that is, hangs down, remove the lever and increase the width of the slot in the thick end.

c. If the lever presses the bar too far away from barrel, decrease the width of the slot.

3. Pull the wire out slightly and cut it off close to the barrel with diagonal pliers. (Tool No. 8). The wire should be cut short enough so that neither end extends out of the barrel when it is pushed back into place.

4. Fill in holes with wax the same color as the barrel.

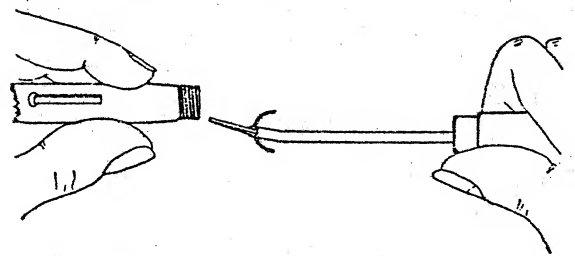

8

Bar and Lever Adjustment

The bar and lever are in proper adjustment when the lever, in a raised position, is stopped by the bar at a right angle with the barrel. Should bar stop lever before it is at a right angle, the bar should be pushed farther into barrel.

If the lever goes beyond a right angle the bar has been pushed too far and should be pulled back until lever is again at right angles. Should the lever turn over, straighten bar in the barrel so lever will strike the top. The lever must be closed when making adjustments on the bar.

Bar Assembly

1. The two piece bar with collar is used on all flat end barrels and streamlined balance barrels with solid ends.

To remove this bar, use bar puller with solid hook (Tool No. 5).

To assemble—grasp collar as illustrated. See illustration No. 3. Then start it into barrel with bar in line with lever slot. Use bar pusher (Tool No. 3) to push bar into place. Test for correct position as outlined above.

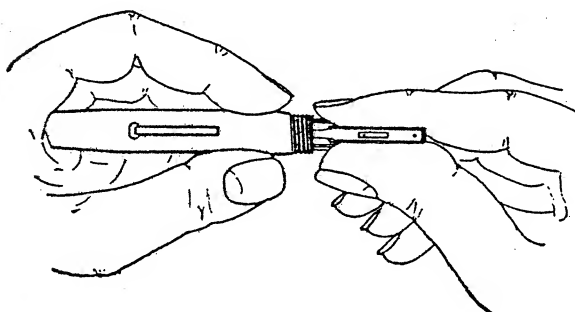

3

2. The embossed, one piece bar with single hook (see illustration No. 4) is used in regular and small size balance barrels with hollow ends.

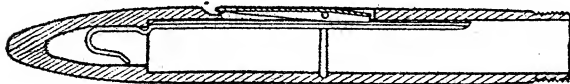

4

To remove this bar, use the two pronged hook (Tool No. 6) as illustrated. See illustration No. 5.

2A. To place this bar in a barrel, first place it on bar pusher, and then push into position. (You can use either Tool No. 3 or Tool No.

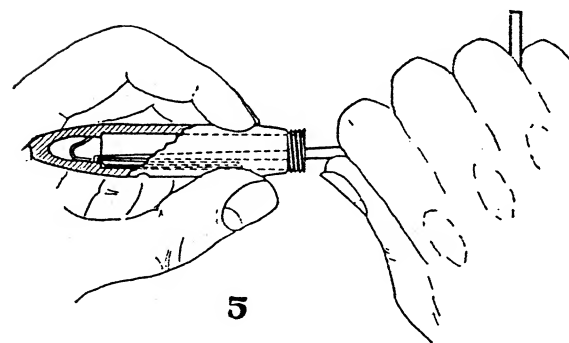

5

43.) Test for "play" as outlined on page 9.

3. The embossed, one piece bar with double reverse hook (See illustration No. 6) is used in large "No. 8" size balance barrels with hollow ends.

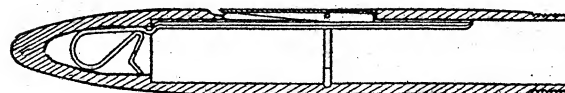

6

To remove this bar, use the two pronged hook. (Tool No. 6). See illustration No. 7. To place this

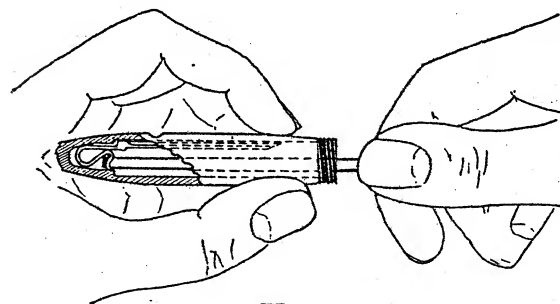

7

bar in a barrel, follow instruction No. 2A above, except that it is necessary to push on reverse hook to set bar in place. (You may use Tool No. 3 or Tool No. 44.) Test for "play" as outlined on page 9.

IMPORTANT: Any style bar must be straight when assembled and must lie close against the inside barrel wall. It must not press on the sac for such pressure will cause a pen to flow unevenly.

HOW TO ADJUST VACUUM PENS

A. To Remove Plunger from Vacuum Type Pen:

1. Empty the writing fluid by working plunger.

2. Rinse pen by flushing with clear water. Continue rinsing until barrel is clean.

3. Unscrew section. To loosen, use section pliers (Tool No. 19). Wrap two thicknesses of rubber (Tool No. 20) around section to protect it from marring and slipping. See illustration No. 9 on page 8.

4. Remove barrel cap from plunger. Hold lock-nut with lock-nut wrench (Tool No. 15) and turn radite barrel cap to left. See illustration No. 10. On WASP CLIPPER vacuum pens, loosen lock-nut with slotted screw driver, (Tool No. 14), then unscrew lock-nut.

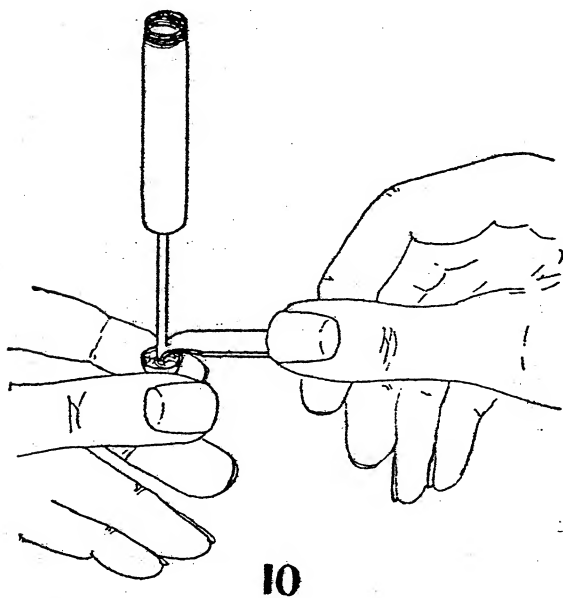

5. Push plunger rod as far as it will go down into barrel; then with plunger removing tool (Tool No. 13), push plunger rod through barrel plug and out of barrel.

B. To Replace Plunger in Vacuum Type Pen.

1. Place plunger lead (Tool 17) on threads of plunger rod and push

into barrel from section end. See illustration No. 12. With plunger assembly tool (Tool 16), push into barrel as far as it will go. See illustration No. 13.

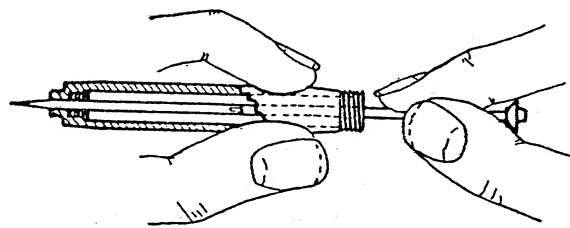

12

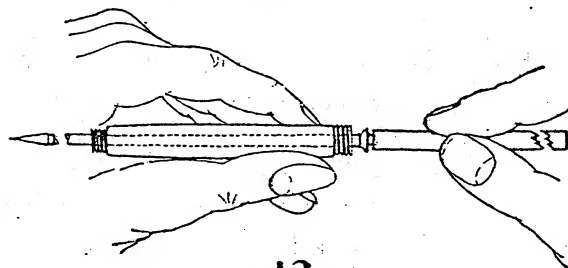

13

2. Screw lock-nut on plunger rod. Then screw on barrel cap. Tighten lock-nut against barrel cap with wrench. See illustration No. 10.

On WASP CLIPPER pens, screw large brass button on plunger rod first; then screw on small lock-nut and tighten with slotted screw driver. See illustration No. 11.

Start section into barrel and tighten, using pliers and piece of rubber. See illustration No. 9 on page 8. The shoulder of section must be drawn up firmly against the barrel but not enough to bulge barrel threads and cause cap to bind.

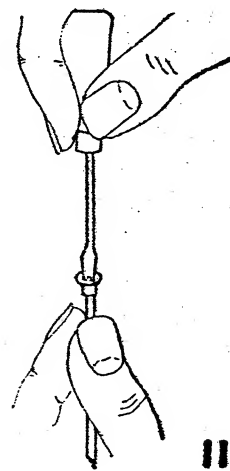

11

BARREL PLUGS—The barrel plug containing the plunger pack-

ing unit is cemented into the barrels of all vacuum pens with the exception of a few of the older models.

To replace this packing unit, the plug must be drilled out and a new one cemented in. Then the barrel cap must be refit.

It is not practical for the average repair man to attempt this replacement.

IMPORTANT: Each size of the vacuum pen has a plunger designed to fit it. The correct plunger must be assembled in the barrel or the pen will not work. If the rod is too long or too short, pen will neither fill nor flow as it should.

When correctly assembled, the plunger washer should not be more than 1/32 (.8 mm.) of an inch from being exactly in the middle of the recess when the barrel cap is screwed on barrel.

Examine the vacuum type demonstrator pen to see how the plunger should be assembled.

There are but three diameters of plunger washers—No. 2 or small diameter, No. 4 or medium diameter, and No. 8, or large diameter. The plungers can be best identified by measuring the hard rubber rod length. See illustration No. 41. Dimension A indicates rubber rod

length; dimension B indicates plunger washer size.

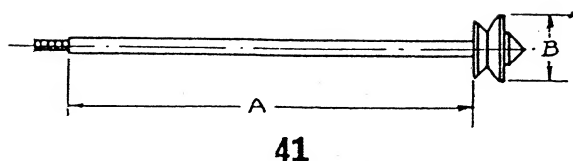

In addition, separate plungers are needed to fit the old style barrel and the new style barrel. Note illustration No. 40. After determin-

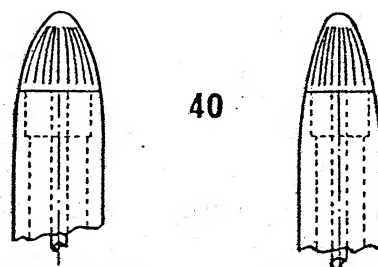

ing whether repairs are to be made on an old style or a new style vacuum pen by judging the barrel's shape according to illustration No. 40, and after measuring the hard rubber rod length, then refer to chart below or to charts on page 13. By following chart and the above instructions, the proper length plunger can be selected.

Caution: The difference in plunger length is due to the taper of the new style barrel as compared to the old. The old style requires a longer plunger rod as indicated by the lower chart on opposite page.

PLUNGER ASSORTMENT FOR WASP CLIPPER AND VACUUM-FIL PENS			
Symbol Number	Hard Rubber Rod Length	Plunger Washer Size	Used in Barrels
V8	2 $\frac{3}{4}$ " (64.5 mm.)	No. 8 Large	{ V8 V6 3835
5200	2 $\frac{7}{8}$ " (62.5 mm.)	No. 2 Small	{ V2 5200 Line
5900	1 $\frac{5}{8}$ " (49.3 mm.)	No. 2 Small	6900 Line
5400	2 $\frac{7}{8}$ " (62.5 mm.)	No. 4 Medium	{ 5400 5500 5800 Line
5700	2 $\frac{3}{4}$ " (63.7 mm.)	No. 8 Large	{ 5700 5800 Line

indicates

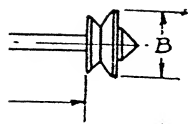

ungers are
style barrel
rel. Note
r determin-

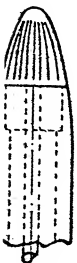

V STYLE

to be made
style vac-
he barrel's
tration No.
y the hard
n refer to
s on page
t and the
proper
elected.

in plunger
per of the
mpared to
requires a
dicated by
osite page.

JUM-FIL

Used in
barrels

- V8
- V6
- 3835
- V2
- 5200 Line
- 5900 Line
- 5400
- 5500
- 5800 Line
- 5700
- 5800 Line

PLUNGER ASSORTMENT FOR NEW STYLE TAPERED END SHEAFFER PENS

Symbol Number	Hard Rubber Rod Length (See Part A, Illustration No. 41)	Plunger Washer Size (See Part B, Illustration No. 41)	Used in Barrels
5W	2 $\frac{1}{8}$ " (58.9 mm.)	No. 4 Medium	{ (74W) Statesman { (5W) Admiral
8W	2 $\frac{5}{8}$ " (59.3 mm.)	No. 8 Large	(8W) Premier
3WS	2 $\frac{5}{4}$ " (53.3 mm.)	No. 2 Small	{ (73WS) Lady Sheaffer { (53WS) Milady { (3WS) Miss Universe { (2WS) Junior
73W	2 $\frac{5}{8}$ " (59.3 mm.)	No. 2 Small	{ (73W) Sovereign { (3W) Craftsman { (2W) Junior
73WH	2 $\frac{7}{32}$ " (56.9 mm.)	No. 2 Small	{ (73WH) Vigilant { (3WH) Commandant
74WH	2 $\frac{1}{4}$ " (56.5 mm.)	No. 4 Medium	{ (74WH) Valiant { (5WH) Defender

All Metal Cap

47W	2 $\frac{5}{8}$ " (59.3 mm.)	No. 4 Medium	(47W) Crest
26WS	2 $\frac{3}{4}$ " (74.9 mm.)	No. 2 Small	(26WS) Lady Crest
46AW	1 $\frac{3}{4}$ " (44.5 mm.)	No. 2 Small	(46AW) Tuckaway

PLUNGER ASSORTMENT FOR OLD STYLE BLUNT END SHEAFFER PENS

Symbol Number	Hard Rubber Rod Length (See Part A, Illustration No. 41)	Plunger Washer Size (See Part B, Illustration No. 41)	Used in Barrels
3WS	2 $\frac{1}{8}$ " (52.9 mm.)	No. 2 Small	{ (3WS) Miss Universe { (2WS) Junior { (53WS) Milady { 7WS
3W	2 $\frac{3}{4}$ " (59.7 mm.)	No. 2 Small	{ (3W) Craftsman { (73W) Sovereign
5W	2 $\frac{3}{4}$ " (59.7 mm.)	No. 4 Medium	{ (5W) Admiral { (74W) Statesman { 7WS
8W	2 $\frac{1}{2}$ " (60.1 mm.)	No. 8 Large	(8W) Premier

HOW TO REPAIR AND ADJUST GOLD POINTS

Inspecting the Gold Point:

Be sure to use a magnifying glass to inspect the point and feed. Place point against bottom of magnifying glass so that it shows through the opening.

Hold the glass as close to the eye as is comfortable.

Continue to hold the pen point against glass as illustrated, to inspect the fit of the feed against point. See illustration No. 25.

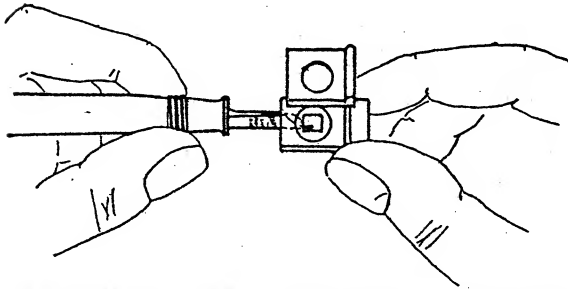

EXAMINING THE IRIIDIUM POINT WITH THE MAGNIFYING GLASS.

25

Turn pen so point faces the glass to inspect the space between the point and iridium tips.

To Remove Gold Point from Section:

This should not be attempted unless you have received instruction from someone familiar with this work, for while it is easy to remove the point, considerable knowledge and skill are required to properly reassemble the point and feed in the section:

1. Check the distance point extends out of section with the point pushing gauge (Tool No. 28). The point should be pushed in section the same distance when pen is re-assembled.

2. Place point and feed in the bench block (Tool No. 25) in smallest hole in which they will fit. Be sure the face of the section is against the block.

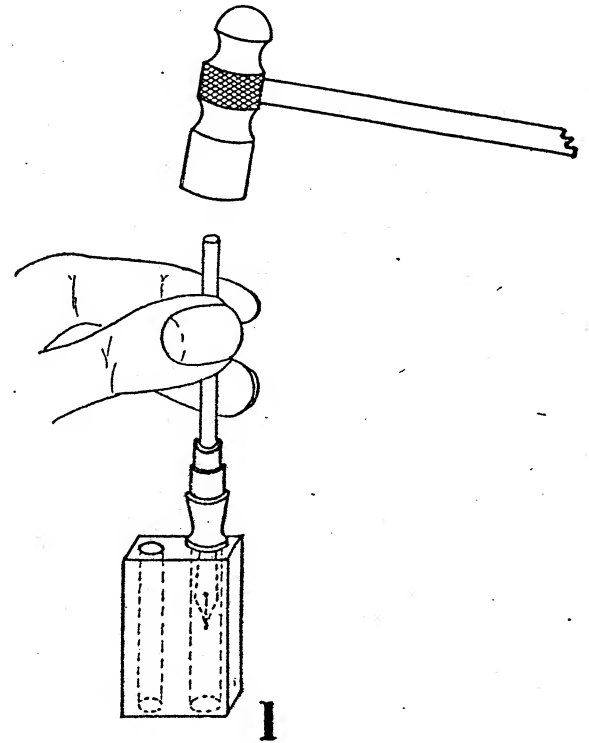

3. Place feed punch (Tool No. 22) on the back end of the feed and drive out feed. See illustration No. 1.

If feed is one of the newer models with an insert extending out of the back end, use special hollow feed punch (Tool 22) to prevent breaking the insert. If feed has no insert, a nail of the correct size with the point ground off will make a good punch.

Hold the back of gold point against edge of hole in the feed block so the hard rubber sleeve (such as those found in transparent sections) will not strip out. Should one come out with the feed, press both back into section and try again, but make certain face of sleeve contacts bench block.

INTS

ed in the
o. 25) in
they will
he section

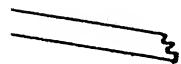

ol No. 22)
e feed and
illustration

ver models
out of the
ollow feed
ent break-
has no int-
t size with
ill make a

int against
l block so
(such as
arent sec-
t. Should
feed, press
and try
n face of
lock.

Straightening the Gold Point:

Points should be straightened and spacing adjusted before pen is re-assembled.

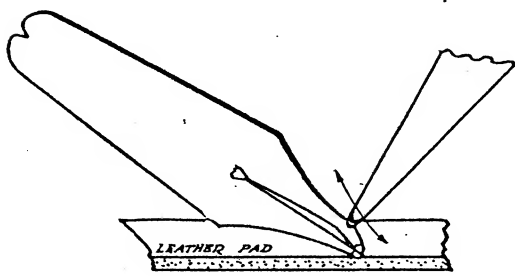

BURNISHING POINT WHICH IS CLOSED AT TIP.

14

Points which are bent in at the tip can be adjusted by burnishing the outside of the point where the bend occurs while the iridium tip is resting on a leather pad. See illustration No. 14.

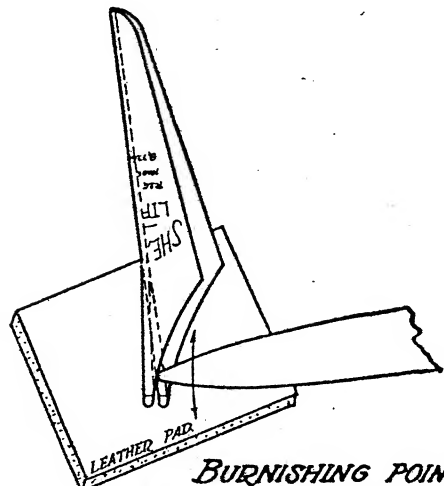

BURNISHING POINT WHICH IS FORKED AT THE CENTER OF SLIT.

15

Points which are forked at the tip are treated as above except that the uppermost side is pushed away with tip of burnisher (Tool No. 30) while burnishing inside of lower point. See illustration No. 15.



POINT CORRECTLY SPACED.

16



INCORRECT. POINT IS OPEN ON THE FACE.

17

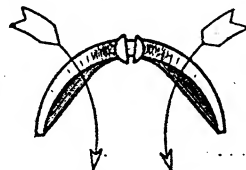

INCORRECT.

BACK.

18

Points must be spaced the same width on the face as on the back. See illustrations Nos. 16, 17, and 18.

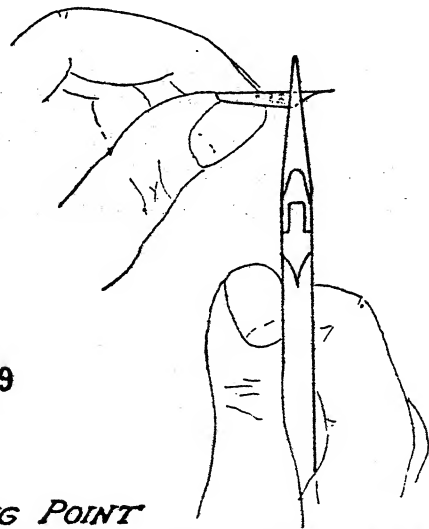

19

CLOSING POINT THAT IS OPEN ON THE FACE.

Points open too wide on the face can be adjusted by springing the

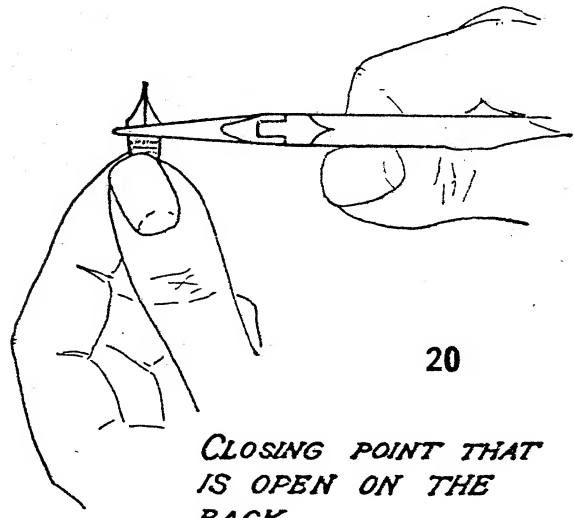

20

CLOSING POINT THAT IS OPEN ON THE BACK.

shoulders of point together slightly. See illustration No. 19.

Points which open wider on the back than on the face (Fig. 18) are adjusted by pressing the point lightly across the heart with the pliers. See illustration No. 20.

Spacing the Gold Point:

The flow of writing fluid is regulated by the width of spacing which varies according to the fineness of the point.

A needle point makes a very fine line and requires little spacing

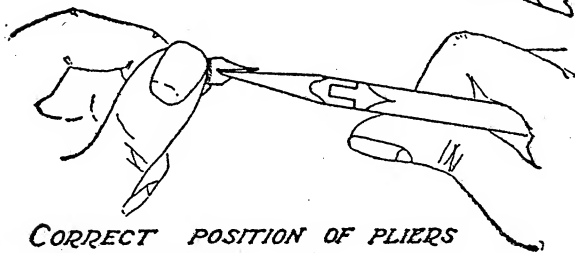
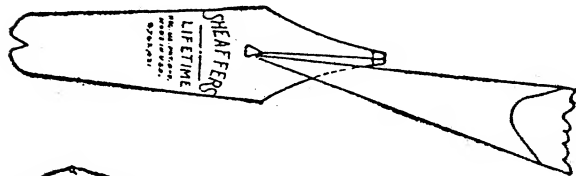

CORRECT POSITION OF PLIERS FOR ADJUSTING NIB.

21

while a coarse point makes a heavy line and requires a wider spacing.

Points should always be spaced far enough apart so light can be seen the entire length of the slit.

Points which do not have enough space are adjusted by raising first one side, then the other, away from the feed or writing surface. Grasp the point with the smooth jaw pliers and lift or spring up alternate sides. Do not make an abrupt bend in the point. See illustration No. 21.

When the point is spaced too much, reverse the process and spring sides down.

Caution: Keep the plier jaws away from the iridium tips or iridium will be broken off. See illustrations Nos. 21 and 22.

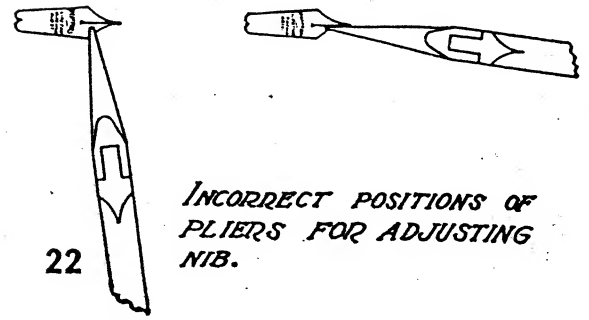

INCORRECT POSITIONS OF PLIERS FOR ADJUSTING NIB.

WHEN THE ADJUSTMENT IS COMPLETED THE IRIDIUM TIPS MUST BE EXACTLY EVEN ON THE WRITING SURFACE.

Replacing the Point in the Section:

Make certain all parts are clean before they are assembled.

The feed should fit snugly in section to hold point tight and to prevent writing fluid from leaking out.

The point should be even along the slit and at the tip before it is pushed.

Pushing the Point:

Place the point squarely on feed. Tip of feed should be about $\frac{1}{8}$

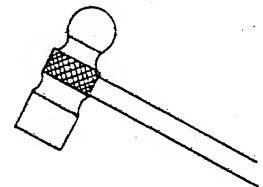

23

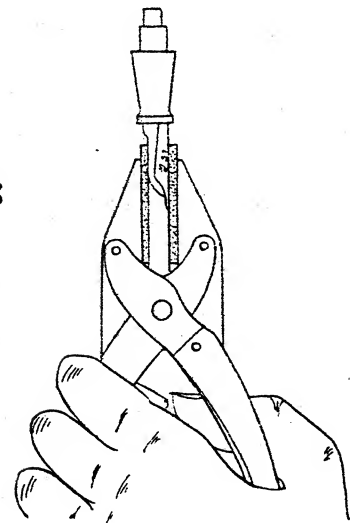

inch (3.2 mm.) back from end of point.

Start feed and point into section with fingers. Grip feed and point in pushing pliers (Tool No. 21). Drive section on to feed and point. See illustration No. 23. Make certain point is pushed far enough by checking on point pushing gauge. This is important for if point extends out too far, the iridium will be broken off when cap is screwed on. Push point to the depth indicated on chart supplied with point pushing gauge. Check point after pushing to make certain it is spaced and lined correctly.

Molding the Feed to the Point:

The feed must fit tightly all along the under side of point to insure a correct flow.

1. The feed is made of hard rubber. By quickly passing it through a flame a number of times, the rubber absorbs heat and becomes pliable.

2. The feed, when pliable, is molded against the point by pressing it with forefinger. When feed has been molded to point, dip it in water. This cools feed causing it to retain its molded form.

Use care to keep the section from heat as it will soften and cause point to loosen.

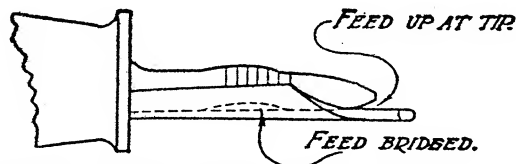

INCORRECT - FEED AWAY FROM POINT. LIGHT SHOWS BETWEEN FEED AND POINT.

26

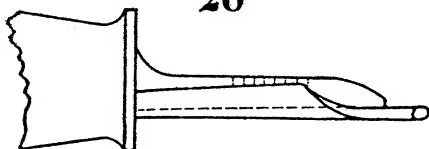

CORRECT - FEED AGAINST POINT. SHOULD SEE NO LIGHT BETWEEN FEED AND POINT.

27

To Inspect

3. Face a light and place point in a horizontal position. See illustration No. 25 on page 14. Examine it with magnifying glass to determine if light shows between feed and point. See illustrations Nos. 26 and 27.

After feed has been properly molded, give point a final inspection to see that it is aligned and "spaced" correctly and that feed is down tight against point.

Fitting the "C" Type Feed to Point:

The new style streamlined or "C" feed is pushed in the same manner as the regular flat comb feed.

Take the magnifying glass and look through the heart piece of point. Inspect narrow ink channel in feed.

This type feed requires heat and pressure only at the tip ends of feed beyond combs.

After fitting feed against point, inspect the ink slot again to see that the slot has not been closed.

Closing very slightly will do no harm, but if it is closed more than half way, the section should be removed and feed and point driven out. The ink slot then may be opened by heating feed, after which it may again be assembled.

Smoothing the Point:

A scratchy point is usually caused by the iridium tips being out of line. Often this is the result of the point having been struck or pushed slightly to one side, causing an uneven pressure of feed against point. This can be corrected by

pushing point back into line with feed, using your fingers.

If tips are even and point scratches, the iridium may have a sharp or rough spot. This is removed on a special grade of fine smoothing paper. This paper should be placed on a firm smooth surface and a light coat of rouge rubbed over it to reduce the cutting power and to polish the iridium.

To smooth point, hold pen in a writing position and slowly move it in small circles. Finish up by writing continuous figure 8's. As the point is moved over the paper, the position of pen should be changed continuously so a flat face will not be worn on point tip. Use only moderate pressure and finger movement in making small circles and figure 8's. See illustration No. 28.

Care and skill must be exercised or more harm than good will be done. Never rub the point on a stone or rough abrasive of any kind. The iridium must have a very smooth, mirror-like finish and any scratch

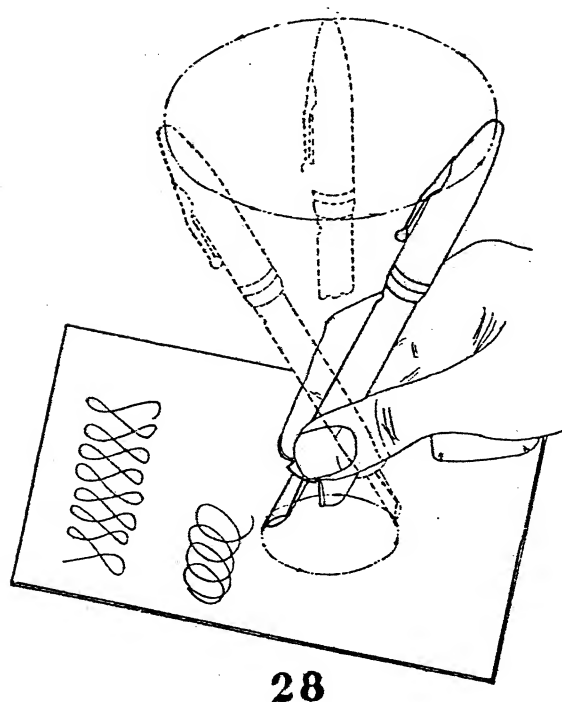

or rough spot will be noticed when point is used.

Fitting the Cap

It is important that the cap fit properly on pen. It should screw on smoothly until the inner cap meets section. An extra twist should then be given cap to make the proper air-tight seal at this joint.

Should the threads in cap become worn to such an extent that cap will not tighten but continues to turn, it will be necessary to send pen to the factory to have the cap rethreaded and fitted to barrel.

The cap should fit snugly enough on the back end of barrel so it will not work off when pen is in use, or fall off when pen is held with the cap down. If the fit is not satisfactory, do not attempt to improve it by roughing up the end of barrel. This ruins the finish and seldom does any good. This adjustment can be made if you have a turning lathe; otherwise, it will be necessary to return it to the factory or a repair shop which has this equipment.

To Increase Clip Tension:

Hold down ball of clip with thumb and raise back of clip with bur-nisher or chain nose pliers. (Tool No. 23). See illustration No. 29.

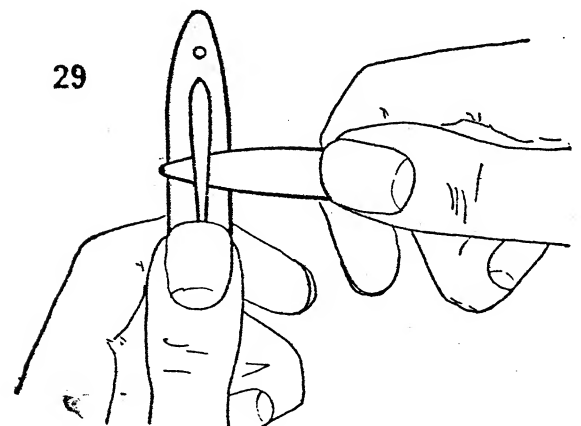

noticed when

the cap fit
ould screw
inner cap
extra twist
ap to make
deal at this

cap become
it that cap
ontinues to
ry to send
ave the cap
o barrel.

gly enough
el so it will
is in use,
held with
is not sat-
tpt to im-
the end of
finish and
. This ad-
if you have
wise, it will
to the fac-
which has

ension:

with thumb
with bur-
iers. (Tool
n No. 29.

HOW TO HANDLE PENCIL REPAIRS

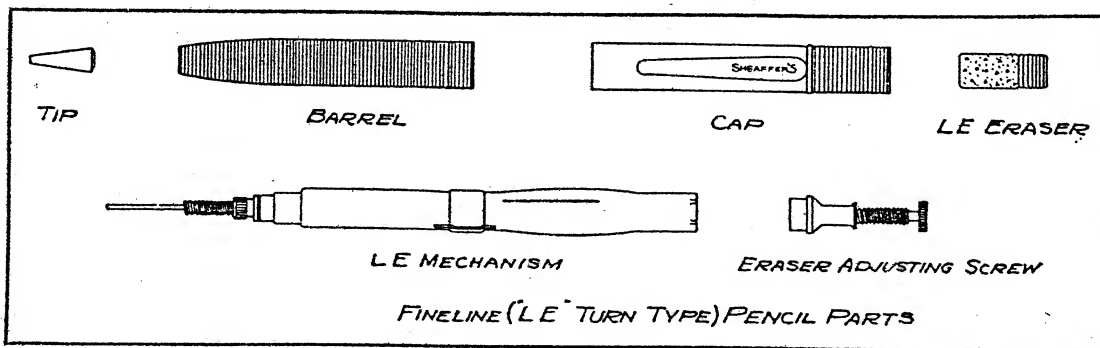
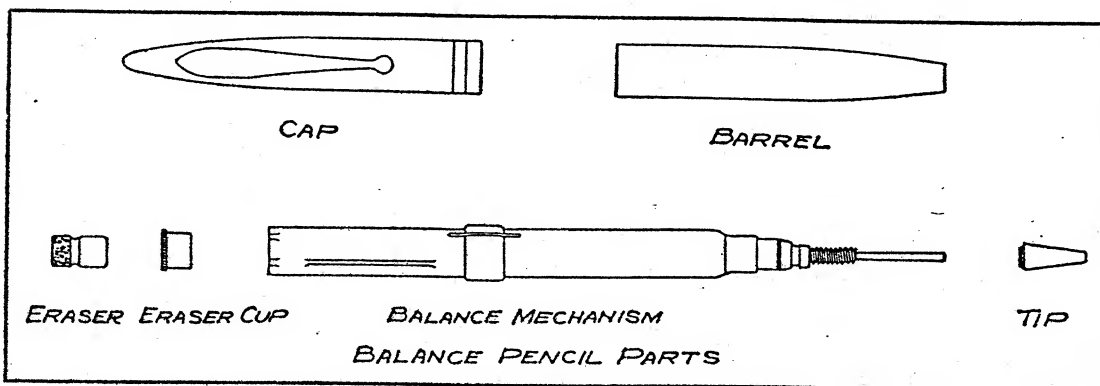
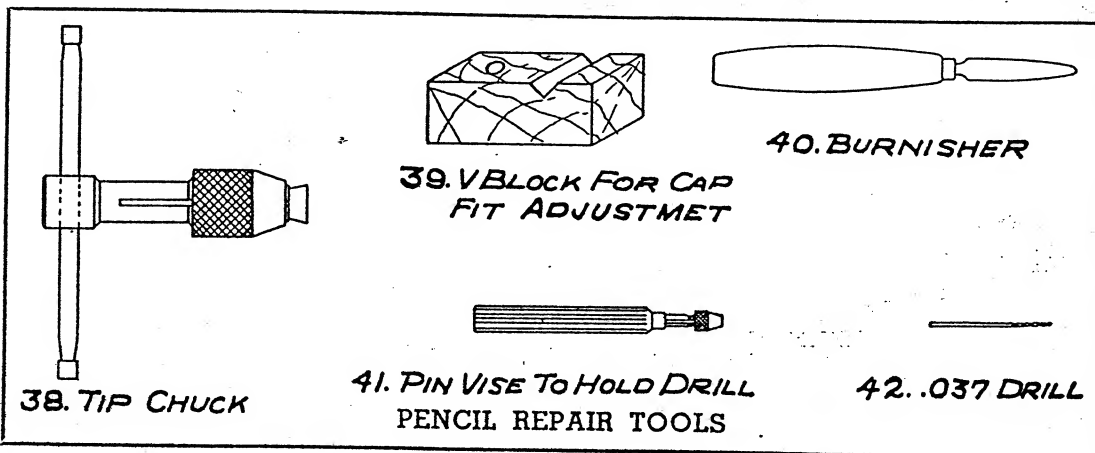

Experience has proven that Sheaffer pencils require very little servicing.

Should for any reason the mechanism fail, the practice is to remove it and supply a new one. This can be done with the proper tools but is not recommended for the average shop.

Many repair shops report that the small number of Sheaffer pencils returned to them for service is not sufficient to make it worth while investing even a small amount in the necessary tools and assortment of mechanisms. However, tools and instructions will be supplied to any who desire them.

HOW TO REPAIR PROPEL, REPEL, EXPEL (Turn Type) PENCILS

(EITHER REGULAR BALANCE, FINELINE BALANCE, OR LE "IN WORKING TOGS" MODELS)

A. Examine pencil for:

1. "Lead jam"
2. Damaged tip
3. Loose cap
4. Mechanism locked in propel and repel
5. Mechanism turns without propelling lead
6. Loose eraser in regular Balance pencil

B. Directions for Repairing:

1. Lead jam

- a. Use tip-chuck (Tool No. 38) to remove tip from end of mechanism. See illustration No. 44.

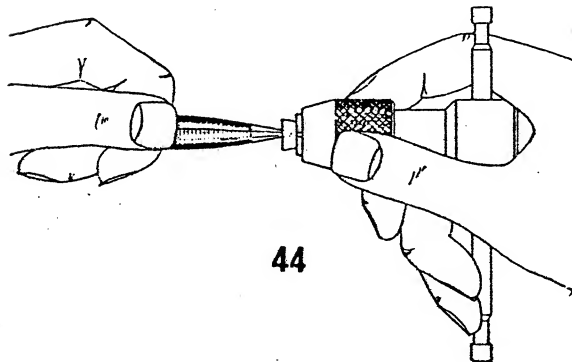

Caution: Do not use pliers for they will damage tip.

- b. Turn mechanism to left-repel position—as far as it will go.

- c. Drill lead out of Fineline pencil tip with .037" drill (Tool No. 42).

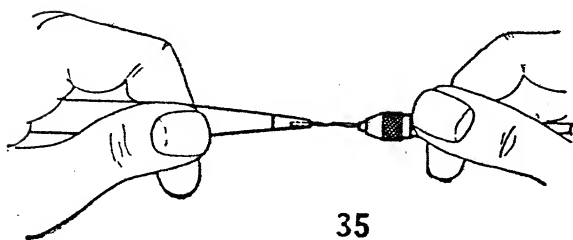

Drill lead out of regular pencil tip with .050" drill. See illustration No. 35. Note different sized drill for two types of pencils.

Caution: It is possible to damage lead carrier if it is struck by drill.

Note: If no chuck is available, use .037" or .050" drill to drill lead out of tip without removing mechanism from pencil. Make sure mechanism is in repel position.

- d. Assemble tip — shellac thread of stem before screwing on tip so it will remain tight.

2. Tip Damaged

Should the tip be damaged at point, that is, the metal dented, partially closing the hole, the tip should be dressed off square with a fine file and the hole reamed out and resized with a .037" or .050" drill.

3. Loose Cap

There are two types of lead magazines in the Fineline propel, repel, expel mechanism.

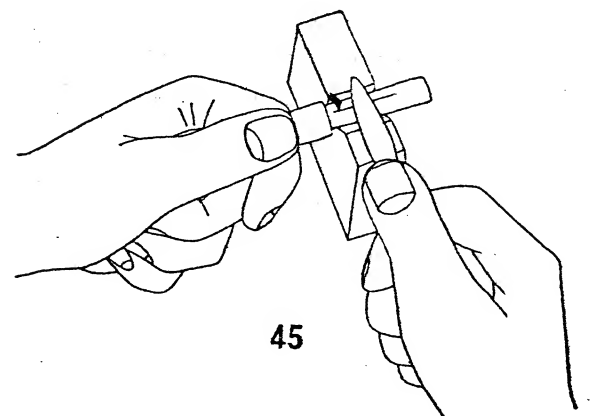

NCILS

ING TOGS"

regular pen-
drill. See
Note dif-
two types

ble to dam-
t is struck

s available,
rill to drill
out remov-
om pencil.
ism is in

shellac
ore screw-
will remain

amaged at
al dented,
le, the tip
quare with
le reamed
a .037" or

lead maga-
pel, repel,

To increase the "cap fit" tension on the new style lead magazine (see either Fineline or Balance pencil parts, p. 19), remove cap and place magazine in "V" groove of wooden cap fit block (Tool No. 39). Be certain milled slit faces directly up. Place burnisher directly on slit and work back and forth to flatten magazine. See illustration No. 45. Then, make a one-third turn with barrel and complete same operation on two other sides of lead magazine section.

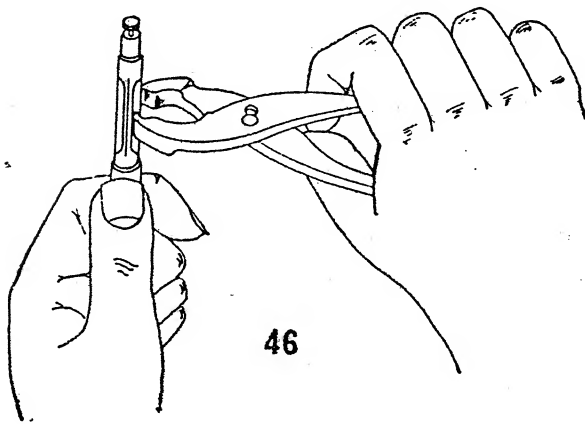

To increase "cap fit" tension on the old style lead magazine (see illustration No. 46), use cap fit pliers (Tool No. 19) and slightly "pinch up" the corrugations. This will increase the over-all diameter of the magazine.

Caution: Use very little pressure for this can be easily overdone in handling either type mechanism. Be certain to remove all lead from magazine in either case.

4 and 5. If mechanism is locked in "propel" or "repel" position, or turns without propelling lead, the mechanism is probably damaged beyond repair and will have to be replaced.

Remove tip from pencil using tip chuck. Place stem of mechanism against bench and push out of barrel.

Supply new mechanism of same type. Insert in barrel.

Shellac threads of stem. Start tip on stem and tighten with the tip chuck.

6. To tighten loose eraser fit, roll end of lead magazine as indicated in illustration No. 33.

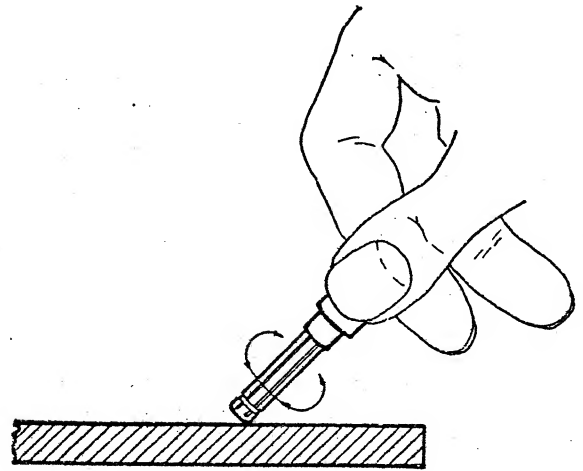

(Note: When ordering pencil mechanisms from the factory, be certain to indicate correct length. Also, indicate whether a Clicker (push type) mechanism or a propel-repel-expel (turn type) mechanism is needed. For balance type pencils, refer to illustration at top of page 22, showing the three lengths in which these mechanisms are supplied.)

In addition to indicating proper length of mechanism, also indicate whether you want the BALANCE pencil mechanism using a regular .046 lead, or a FINELINE balance pencil mechanism using .036 lead.

For FINELINE balance pencils, order No. 5 mechanisms in either LV, LT, or SLT lengths. For regular BALANCE pencils, order No. 4 mechanism in one of these three lengths illustrated.)

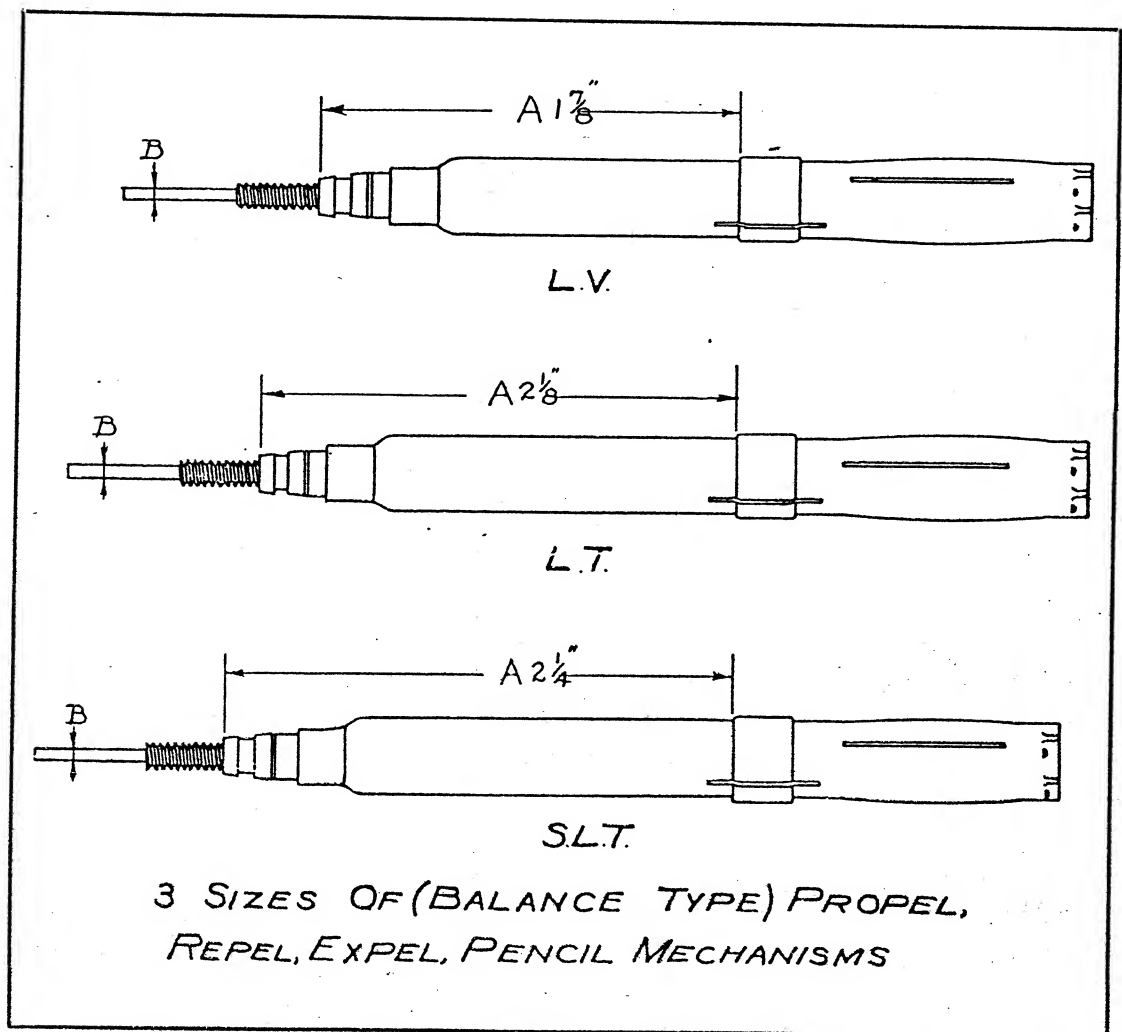

HOW TO REPAIR THE "CLICKER" (Push Type) PENCIL

No tools are necessary and none should be used to change "Clicker" (push type) mechanisms.

A. To Replace Mechanism (see illustration of mechanism on page 23):

1. Unscrew tip part way, using only your fingers and a piece of rubber. Place end of tip against the bench and push to loosen mechanism.

2. Remove tip and lift out mechanism.

3. Supply new mechanism; spread special "Clicker" tip cement on tip threads and replace tip.

Use special "Clicker" tip cement, not shellac, on tip threads. Tighten only with fingers and a piece of rubber.

B. Correct "Clicker" pencil complaints as indicated:

1. Lead will not feed.

a. Check lead for correct size and uniform diameter.

b. Remove tip and ream it out with .037" drill, or—

c. Supply new mechanism.

2. Lead Jammed.

a. Remove tip and ream it out with .037" drill.

b. See that lead operates through mechanism when tip is removed.

3. Lead breaks.

Supply new mechanism.

4. Lead pushes back.

Supply new mechanism.

5. Loose fitting eraser.

Force sharp tool or knife blade between the barrel and top edge of magazine.

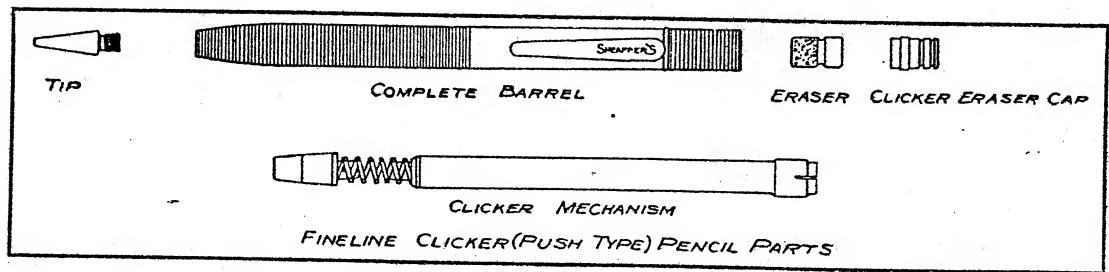

PENCIL

mechanism;
tip cement
the tip.

to cement,
Tighten
piece of

pencil com-

correct size
r.

"AT YOUR SERVICE"

We sincerely hope this repair manual has been and will be of great assistance to you. Our repair department will be glad to answer your questions at any time and help you with your repair problems. For "tips" on handling pen repair requests and customers' complaints, write for our booklet "The Service Way to More Sales."

W. A. SHEAFFER PEN COMPANY

Fort Madison, Iowa, U.S.A.